

© 2013 NS Design

The contents of this document, including all graphics, are the property of NS Design. NS Design has made every reasonable effort to ensure that all the information contained in this manual is correct at the time of publishing. However, NS Design reserves the right to make any changes necessary without notice as part of ongoing product development.

Radius™ and Polar™ are trademarks of NS Design

Visit NS Design at <http://thinkns.com>

Overview (Front)	5
Overview (Back)	7
Re-Stringing and Tuning	8
Setting Up the Bass	15
Setting the intonation	17
Setting the action	19
Adjusting the truss rod	21
Replacing the Batteries	23
Specifications	24
Accessories	25

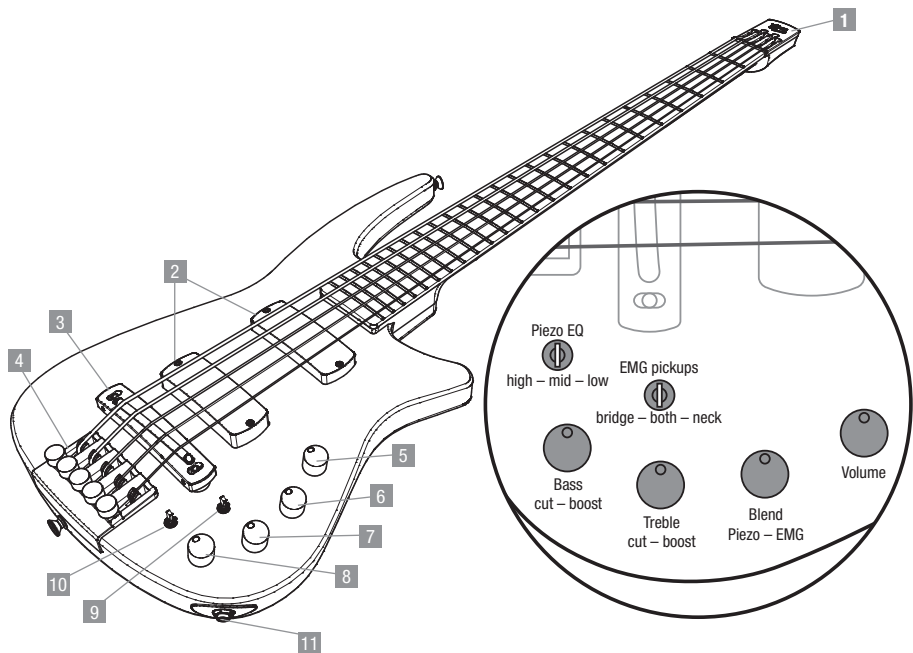

Overview (Front)

Overview	Features
1 Aluminum headplate	with ball-end string mounting slots
2 Magnetic pickups (EMG)	unique design matched to the fretboard radius
3 Bridge	with one piece aluminum saddle and integrated Polar Piezo pickup system
4 Tuner housing	with self-clamping precision tuning system
5 Volume pot	for both piezo and magnetic pickups
6 Blend pot	with center detent, blending between piezo and magnetic pickups
7 Active treble boost/cut pot	with center detent
8 Active bass boost/cut pot	with center detent
9 Pickup selector switch for magnetic pickups	3-position switch
10 Piezo EQ switch	3-position switch
11 Output jack	

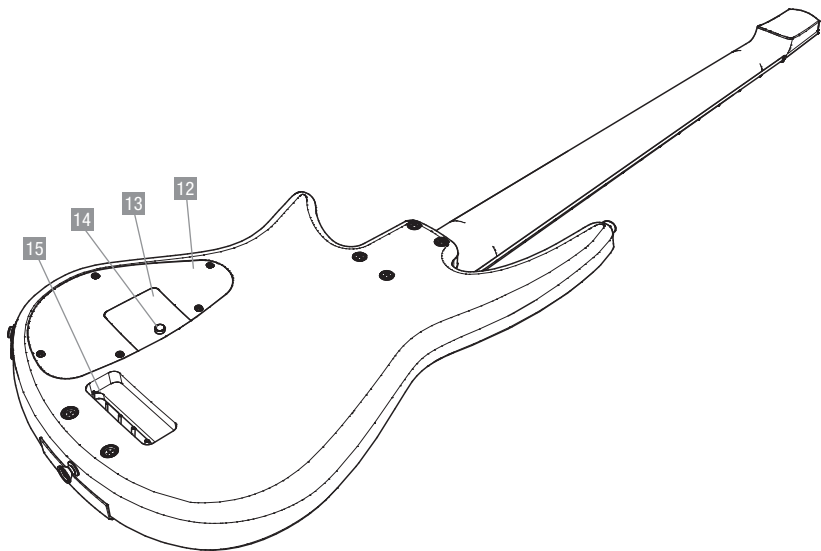

Overview (Back)

Overview	Features
12 Electronics compartment cover	
13 Battery compartment cover	can be opened separately for battery replacement
14 Thumb screw	for battery compartment cover
15 String aperture	

Re-Stringing and Tuning

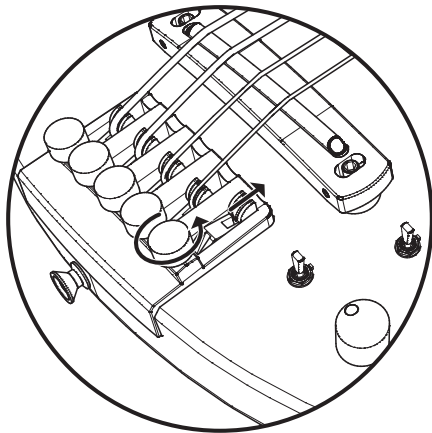

This bass accepts any standard single-ball end, full-scale bass guitar strings. The way the strings are clamped leaves them undamaged and without the usual windings on the end. This lets you easily take them out (e.g. for cleaning) and put them back on the bass as often as desired.

- 1 Turn the tuning knob fully counter-clockwise to loosen the string, until the slotted tuning arm is in the frontmost position (towards the bridge).

The clamping mechanism opens up and you can pull the string(s) out.

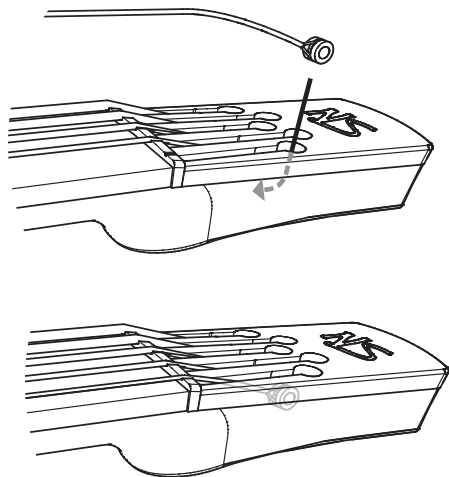

To install strings:

- 2 Put the ball end of the new string into the slot on the headplate.
- 3 Pull the string towards the neck and guide it over the nut.

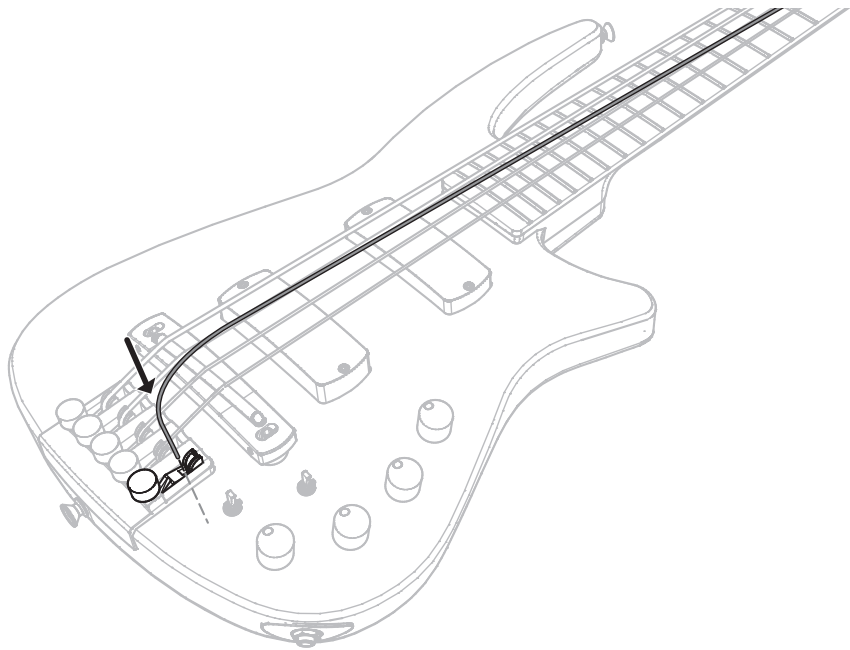

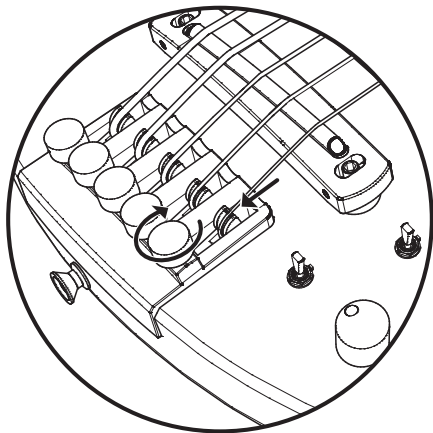

- 4 Guide the other end of the string through the opening behind the slotted tuning arm.

If you have difficulties to guide the string into the tuning mechanism, check if the tuning arm is in the frontmost position (which at the same time fully opens up the clamping mechanism).

- 5 Push the string through the tuner housing (and the bass body) as far as it will go, and hold it with one finger in this position.
- 6 Turn the tuning knob clockwise to close the clamping mechanism, which now tightly holds the string. This happens shortly after the string holder has started moving back.
- 7 Continue rotating the tuning knob until the string is tuned to pitch.

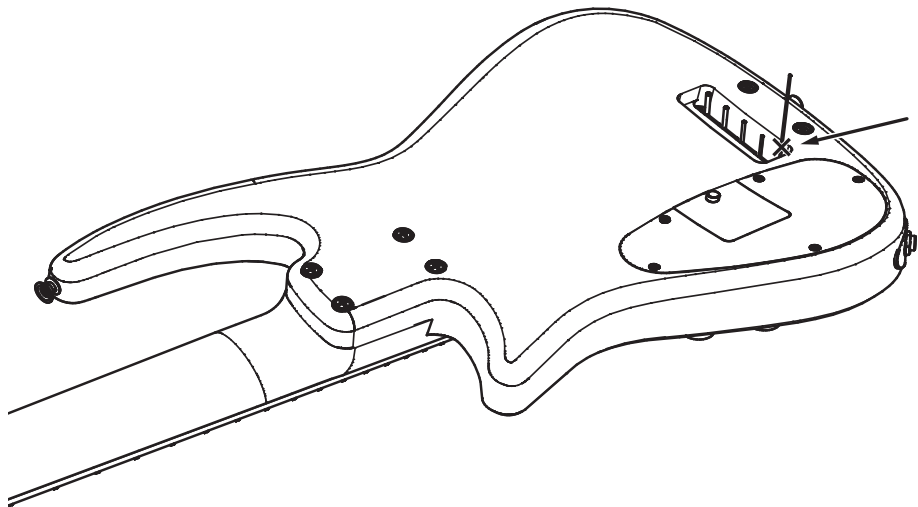

After all strings are installed and tuned up to pitch:

- 8 Turn the bass over.
- 9 Cut the strings within the recessed aperture of the body, so that their ends don't stick out.



Bass strings are hard and may have sharp or pointy ends. Only use appropriate cutters to cut the ends of the strings. Otherwise you might injure yourself or damage the bass.

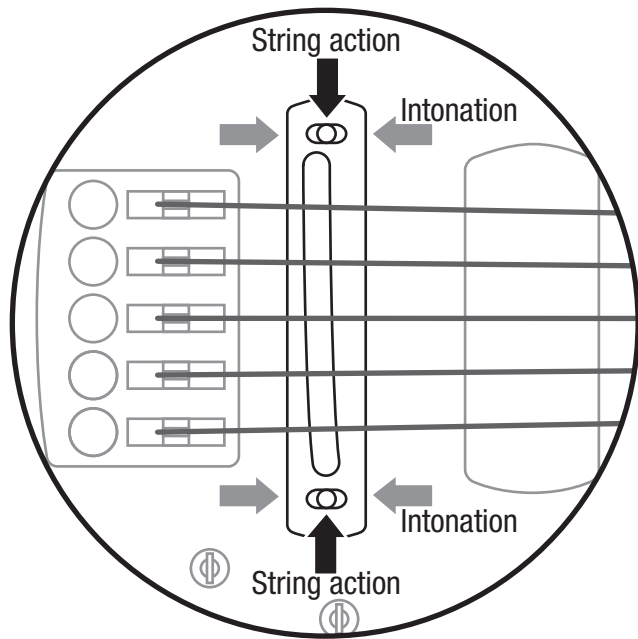

Setting Up the Bass



If you are not familiar with setting up a bass, you should ask a qualified bass and guitar technician for help. Most set-up steps are easy, but if done wrong there is potential damage to the instrument.

Your bass has left the factory with the set-up already done. Additionally, the neck is very stiff due to the carbon fiber core and the truss rod, which makes it highly insensitive to environmental influences. Changing the set-up is generally only necessary if a higher or lower action is desired, or when using a different string gauge which exerts different tension on the neck.

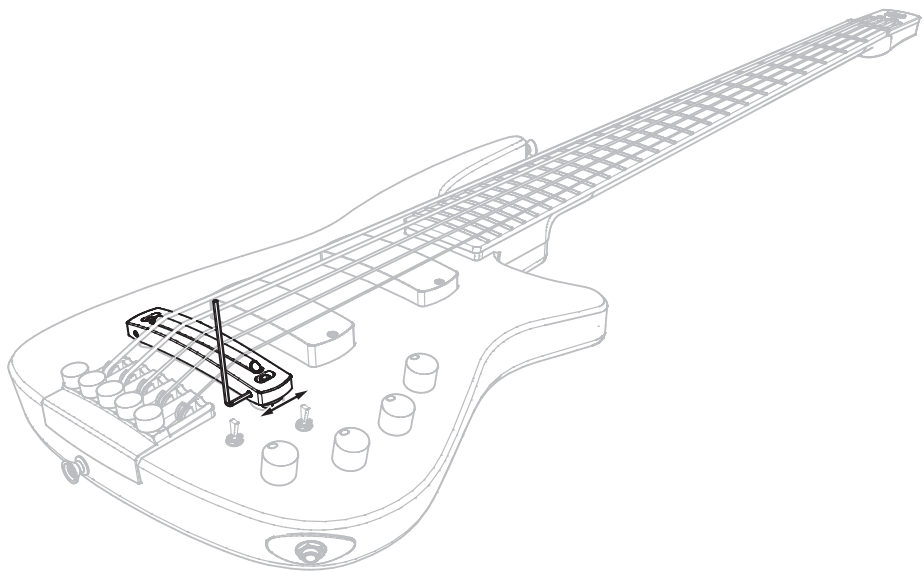

Setting the intonation

If the intonation becomes **flat** when the strings are played at the higher frets, the bridge should be moved slightly **closer to the neck**.

If the intonation becomes **sharp** when the strings are played at the higher frets, the bridge should be moved slightly **closer to the tuners**.

The horizontal bridge position is locked by two screws on each side (3/32" hex wrench, provided with the bass). By loosening these screws you are able to move the bridge on the respective side back and forth to adjust intonation.

To move the bridge **towards the neck**:

- 1 Loosen the screw on the tuner side of the bridge and push the bridge into the desired position.
- 2 Turn in the previously loosened screw until it slightly touches the bridge post.
- 3 Tighten the screw on the neck side of the bridge.

To move the bridge **towards the tuners**:

- 1 Loosen the screw on the neck side of the bridge and push the bridge into the desired position.
- 2 Turn in the previously loosened screw until it slightly touches the bridge post.
- 3 Tighten the screw on the tuner side of the bridge.

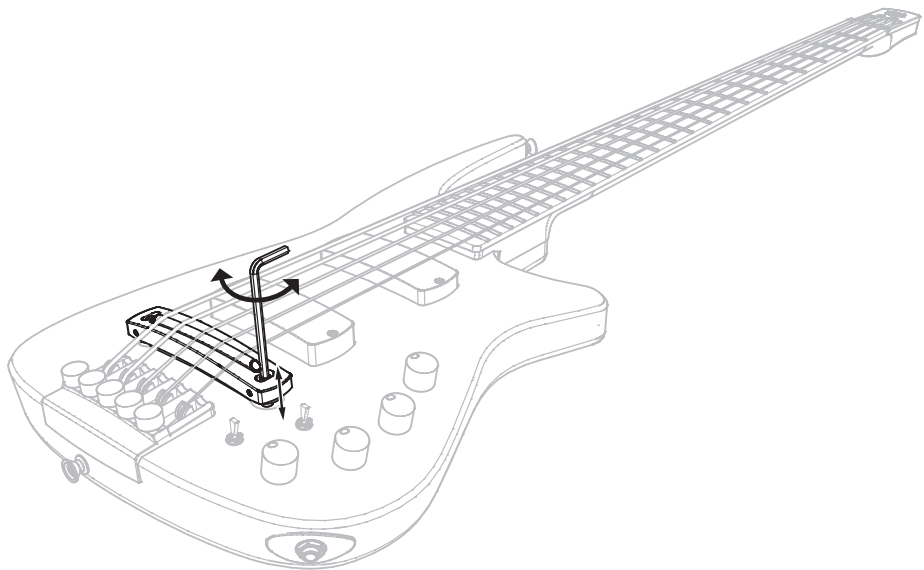

Setting the action

The bridge has two posts which can individually be adjusted for each side. To set up the string action:

- 1 Using a 3/32" hex wrench, slightly loosen **one** of the screws locking the bridge on the bridge post (see page 17).
- 2 Put a 5/32" hex wrench (provided with the bass) into the bridge post.
- 3 Turn the hex wrench
 - counter-clockwise to raise this side of the bridge, or
 - clockwise to lower this side of the bridge.
- 4 When the bridge height is correctly adjusted, tighten the previously loosened screw again.

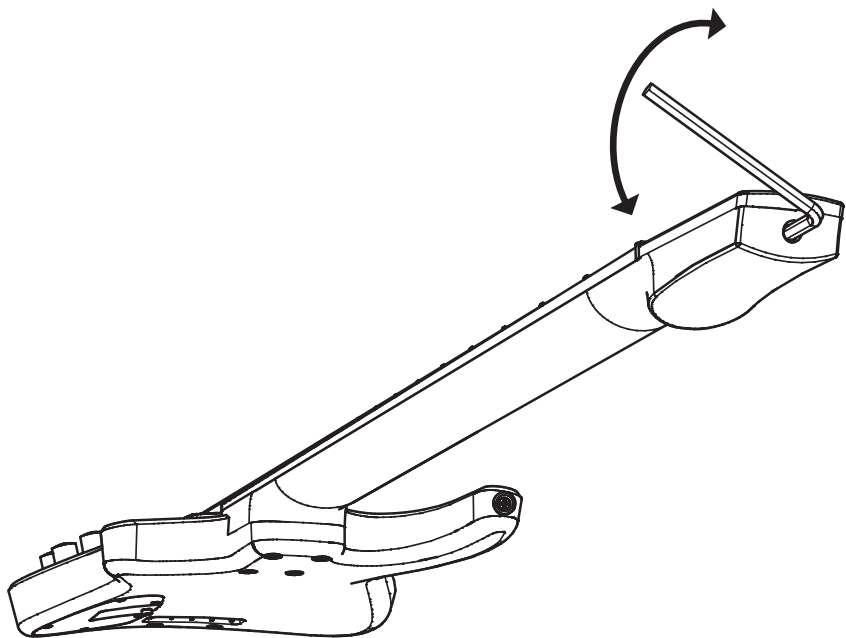

Adjusting the truss rod



Improper truss rod adjustment can **permanently damage the neck**. If you are unsure why and how to adjust neck relief, ask a qualified guitar and bass technician for help.

For adjustment, use a 5 mm hex wrench (provided with the bass).

- Turn the hex wrench counter-clockwise to lower the tension of the truss rod (the neck bows more due to the string tension), or
- Turn the hex wrench clockwise to increase the tension of the truss rod (the neck gets straighter)

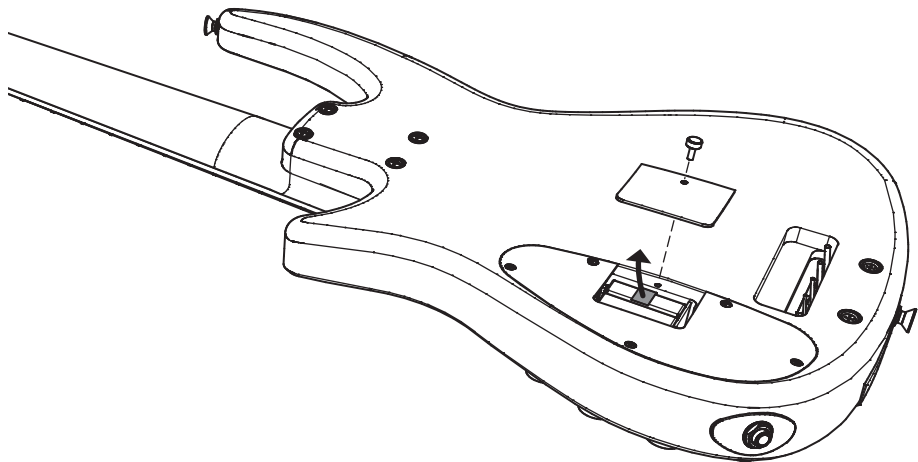

Replacing the Batteries

The active preamp/EQ in your bass is supplied by two 9V batteries. To replace the batteries:

- 1 Open the thumb screw on the battery compartment cover.
- 2 Remove the cover.
- 3 Pull on the strip protruding behind the upper battery. This will pull the batteries out of the battery holder.
- 4 Remove the battery clips from the batteries.
- 5 Install the new batteries in reverse order, and make sure the strip still sticks out when finished.

Always replace both batteries at the same time. Don't mix used and new batteries. Dispose of the batteries according to your local regulations and in an environmentally responsible manner.

Specifications

	CR4	CR5
Overall Length	41.5"	43"
Body Length	20.8"	20.8"
Neck scale	34"	35"
Neck radius	15"	15"
Weight	8.4 lbs / 3,8 kg	8.63 lbs / 3,9 kg
Bridge Spacing	19 mm	18 mm
Nut Width	1.60"	1.85"
12th Fret Width	2.19"	2.54"
Power supply	2 x 9V	2 x 9V
Magnetic pickups	EMG	EMG
Piezo pickup	Polar™ pickup system	Polar™ pickup system

Accessories

CR Radius Bass Guitar Padded Gig Bag

Tools	7/64" Hex Tool for Pickup Height
	3/32" Hex Tool for Bridge Intonation / Position
	5/32" Hex Wrench for Bridge Height / Action
	5 mm Hex Wrench for Truss Rod Adjustment
Standard Strings for CR Radius Bass *	D'Addario EXL170 Nickel Round Wound Bass Strings

* The CR Radius Bass is designed to accept any long scale bass guitar strings.

Notes:

Notes:

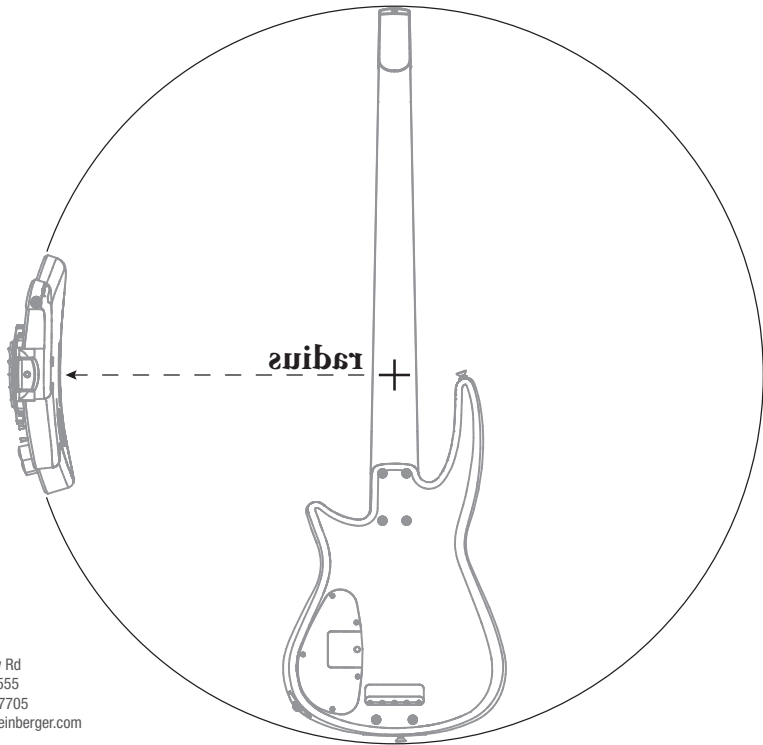

NS Design
134 Back Meadow Rd
Nobleboro, ME 04555
phone: (207) 563-7705
email: info@nedsteinberger.com
<http://thinkns.com>